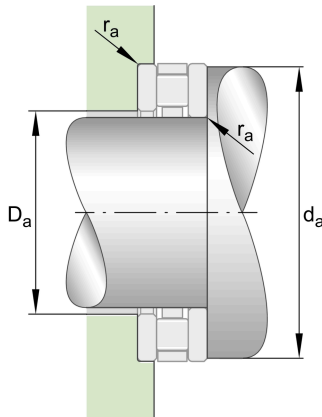
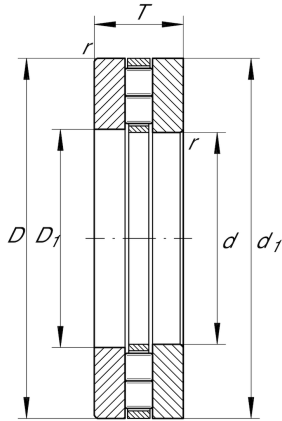
**89309-TV**

Axial cylindrical roller bearing

Schaeffler ID:
0015827200000Axial cylindrical roller bearings 893, single
direction, comprising K893, GS, WS

Technical information

**Main Dimensions & Performance Data**

d	45 mm	Bore diameter
D	85 mm	Outside diameter
T	24 mm	Height
C_a	139,000 N	Basic dynamic load rating, axial
C_{0a}	445,000 N	Basic static load rating, axial
C_{ua}	45,500 N	Fatigue load limit, axial
n_G	4,450 1/min	Limiting speed
n_{gr}	1,620 1/min	Reference speed
	0.613 kg	Weight

Dimensions

	K89309-TV	Axial roller and cage assembly
D_1	47 mm	Bore diameter housing washer
	GS89309	Housing Washer
d_1	85 mm	Rip diameter shaft washer
	WS89309	Shaft washer
B	24 mm	Width
r_{min}	1 mm	Minimum chamfer dimension
D_{c1}	45 mm	Cage bore diameter

Mounting dimensions

d_a	83 mm	Minimum diameter shaft shoulder
D_a	49 mm	Maximum diameter of housing shoulder
r_a	1 mm	Recess radius